



SCAN FOR
E CATALOGUE



FOLLOW US ON
INSTAGRAM

LACASA
SINK YOU DESIRE

Italy Brescello

Design & Global Sales via M.S Ottone, No. 23,
1st floor, Brescello 42041, Italy.
global@lacasasink.com

Indian Sales

Lacasa Sink India - 425, Shivalik Shilp,
Iskcon Road, S.G Highway, Ahmedabad
380 015, Gujarat, India
marketing@lacasasink.com
+91 8758 8758 48

lacasasink.com

SIPR 02.24 (Ver.2.0)

LACASA
SINK YOU DESIRE



Finest Stainless Steel Handmade Sink
Made With Love In India

MAXIMUM
RETAIL PRICE
2026

DESIRE
YOUR KITCHEN
DESIRE
YOUR LIFE

INTRODUCING LACASA SINK

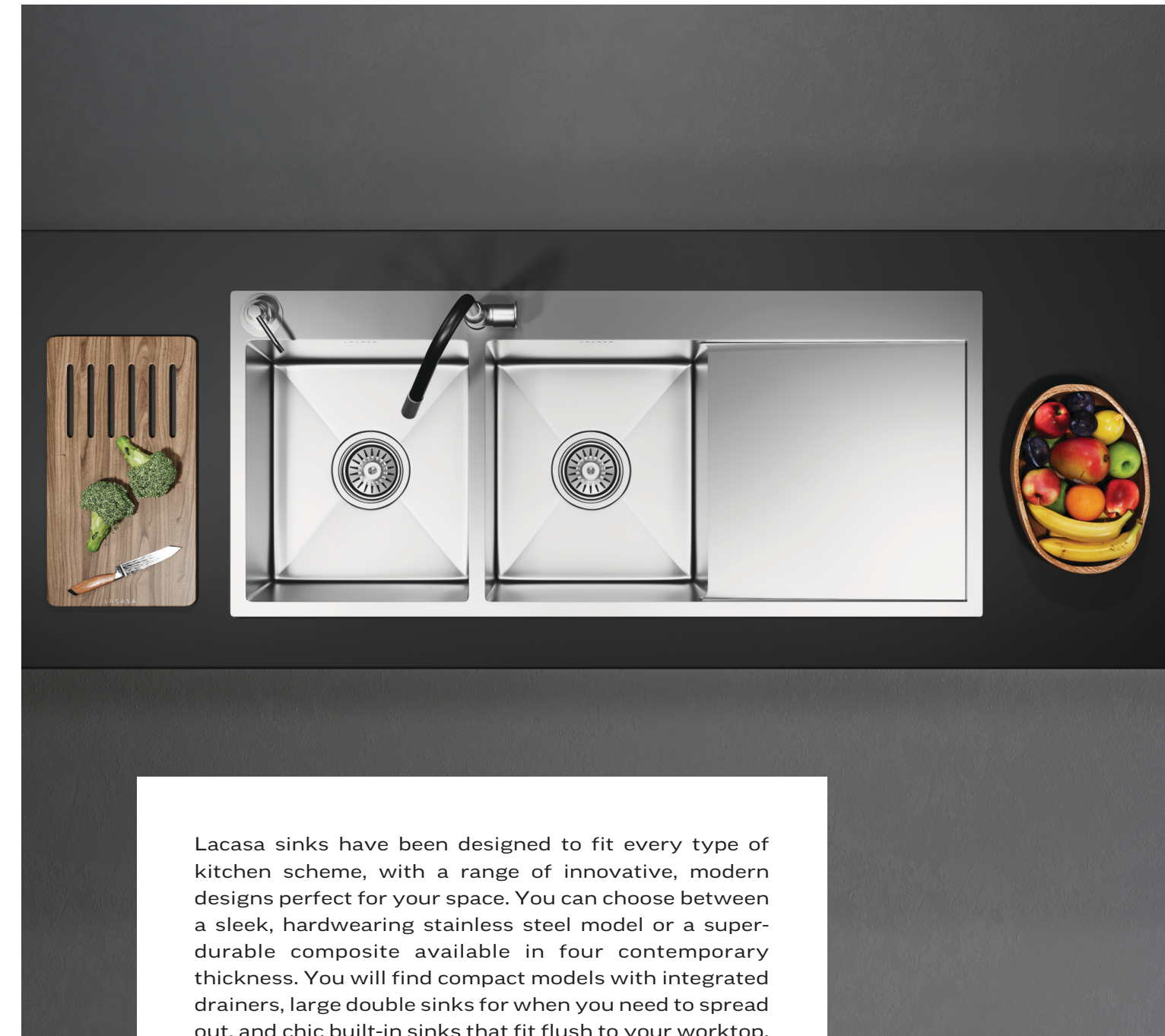

Lacasa sinks have been designed to fit every type of kitchen scheme, with a range of innovative, modern designs perfect for your space. You can choose between a sleek, hardwearing stainless steel model or a super-durable composite available in four contemporary thickness. You will find compact models with integrated drainers, large double sinks for when you need to spread out, and chic built-in sinks that fit flush to your worktop. With features like the Lacasa Quick Fix system, you can have your new Lacasa sink installed in minutes with no fuss or hassle.

We are also confident that you will love the special features like the choke stop free-flow drainer. Thanks to Lacasa Whisper noise defend technology you can even be sure that this will be your quietest sink ever. The sink's outercoat material is Durashield PU Waterproof Coating application that bonds completely to the steel - it helps in maintaining water temperature in sink also improves heat retention in winter. With a sink from Lacasa you'll notice the difference, making every time you use your sink less of a chore.

OUR INFRASTRUCTURE

Lacasa Sink is established in India with the aim of providing complete Kitchen Solution for all sectors and to showcase the possibility of using S.S Sink board with innovative ideas. We are equipped with state of the art automatic production lines along with the finest infrastructure to support growth and productivity helping us serve our partners and clients with nothing but the best.

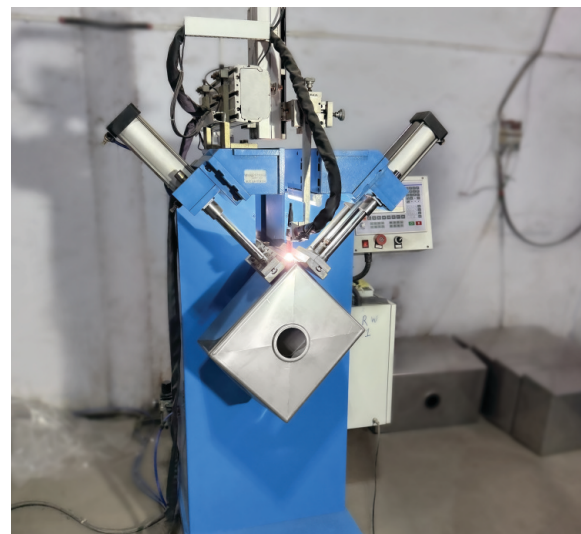

MACHINERY DETAILS

Lacasa Sink invests a lot on automation, like Laser Cutting Machine, Auto Welding, Polishing, Bending and Cleaning Line, (upcoming) Stacking Robot etc., which can ensure stable superior quality steel kitchen sinks maintain.

- ❑ Laser Cutting
- ❑ Bending
- ❑ Auto Welding
- ❑ Auto Polishing
- ❑ Auto Panel Brushing
- ❑ Calibration
- ❑ Inspection (semi)
- ❑ Ultra Cleaning
- ❑ Bowl Brushing
- ❑ Inspection (100%)
- ❑ Noise Defend Pads
- ❑ Corbial Technology
- ❑ Durashiled PU Technology
- ❑ Logo Printing
- ❑ Packing (robotic machine-coming soon)

ADVANCED EQUIPMENTS

- ❑ Laser Cutting Machine: Biggest high accuracy contactless cutting with automation machine across Gujarat region.
- ❑ Digital Bending Machine: We are using 4 excel hydraulic CNC bending machine (Best in India till date).
- ❑ Welding & Auto Panel Welding Machine: CNC fully auto welding machine and we bring in automatic panel welding machine to keep high and stable welding quality, so as to avoid rusting and seaming marks on the AISI sinks.
- ❑ Auto Corner Welding Machine: CNC fully auto corner welding machine deliver accuracy that shows fine precision. While the manual machine does not provide accurate precision. (First time in India)
- ❑ Polishing Machine: Auto brush polishing machine in across Gujarat .
- ❑ Air Pressure Machine: Quality Control air pressure machine to check the leakage in sinks.

MATERIAL SOURING:

Using Authorised Jindal Stainless Steel Sheet For 316 & 304 Grade.

Lacasa has been sharing its passion and dedication in the art of shaping AISI 304 and AISI 316 stainless steel, the heart and soul of our creations.

More than just Raw Material. Our know-how goes beyond selecting raw materials: Every step of the manufacturing process, from assembly to the finishes, with the aim of achieving perfection in every detail. The skilful use of AISI 304 and AISI 316 is our signature, a guarantee that every Lacasa product is an extraordinary combination of beauty and functionality.

Welcome to the world of Lacasa, where steel is turned into a story of excellence.

**Stainless steel
a timeless
ecological choice**



Lacasa posh brush finish stainless steel is created using special vegetable fibre brushes which give it a premium finish with minimal surface roughness. The care given during the process and the special vegetable fibre brushes make it easier to clean the steel.

AISI 304 & 316 FOOD GRADE



AISI 304 **Standard Excellence:**

Our extensive know-how in the use of AISI 304 stainless steel is the secret of our success.

This material, with its chromium and nickel content, is synonymous with corrosion resistance, durability and high tolerance to extreme temperatures.

Also known as 18-8 stainless steel (18% chromium and 8% nickel), AISI 304 is the starting point for creating products that are sturdy, long-lasting and non-porous.

The smooth and hygienic surface of AISI 304 steel is easy to clean and retains its brilliance over the years.

AISI 316 **The Solution for Extreme Challenges:**

The use of AISI 316 steel, known for its exceptional re-sistance to corrosion in harsh environments.

Originally developed for the nautical sector, AISI 316 is resistant to the effects of salt, aggressive detergents and food acids.

This unique material is used in a complete line of Lacasa products suitable for the most demanding environments and challenges.



T-304 FOOD GRADE STAINLESS STEEL

Thicker steel means a stronger sink. Lacasa uses heavy-duty T304 Gauge Stainless Steel resulting in a sink that is noticeably sturdy with a quality look and feel. Sinks constructed using T304 Gauge Stainless Steel offer long-lasting durability, with excellent resistance to corrosion, dents, and damage.

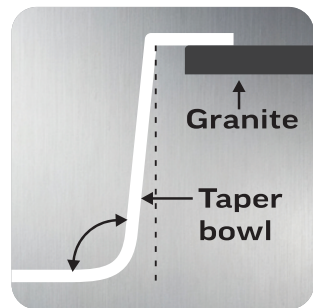

MODERN TAPERED SIDE WALLS

All Lacasa sink are specially designed with narrow slope and tapered side walls to ensure that no dirt or residue ever remains stuck for easy cleaning.

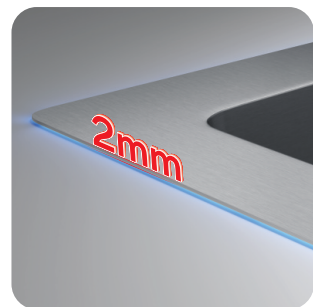

2mm Frame

2mm frame is used in all lacasa handmade sinks. The embodiment of thicker frame give more strength and solid look. We assure a durable sink and a great look.



CORNER R10 RADIUS

All Lacasa sinks are innovated with 10mm radius curved corners designed for easy cleaning, making this bowl sink smooth to clean while reflecting the latest trends in the modern kitchen fashion.



X-DRAIN ASSURE - WATERWAY

An integrated waterway channel that offers enhanced functionality, the X-Drain Assure waterway system is engineered to direct water into the drain even when the sink is full of dishes, helping prevent standing water in the bottom of the bowl.



PROTECT DRAIN

The next generation Protect Drain is the perfect solution to have a clog free drain, The dual anti-clog technology is used to remove waste in smarter way. The first bin helps to stop the large particles from moving down in the drain and clogging it, the second works for finer waste. Easy to clean this drain is a hygienic way of food disposal, and can be emptied out in a bin without any hassle.

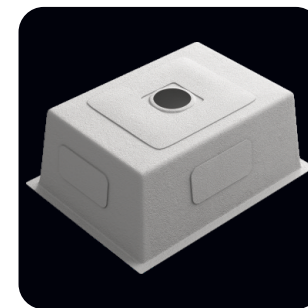

NOISE-DEFEND SOUNDPROOFING TECHNOLOGY

Noise-Defend sound dampening technology features super-silencer pads on all sides of the sink that help prevent noise and vibration from dishes and garbage disposal when the sink is in use.



PROTECTIVE FILM

A protective film coating is mandatory applied to the surface of stainless steel sinks to safeguard them from scratches and damage during shipping and installation. This film is usually a durable, plastic-based material that easily peels off without leaving residue. It should be remove after installation, before use.



NON-MAGNETIC STEEL

Magnet test is a credible test to distinguish Lacasa Kitchen Sinks from their competitor in the market. All Lacasa sinks are guaranteed non-magnetic.



EZY-STACK NESTED PACKAGING

Sinks designed with nested dimensions allow for easy storage and transportation. To accommodate large projects for builders these sinks stack perfectly, increasing efficiency for everything from shipping to delivery to job-site containment.

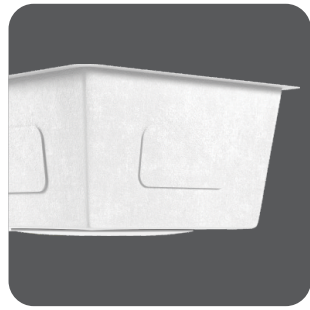

DURASHIELD PU COAT TECHNOLOGY

Durashield PU waterproof coating from house of Lacasa is finish application results in a white color coating that bonds completely to the steel, greatly improving durability and clean ability, odourless with superior resistance to abrasion, chips, and corrosion. It helps in maintaining water temperature in sink, also improves heat retention in winter.

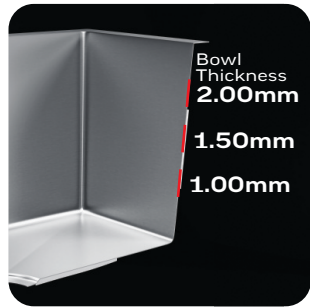

BOWL THICKNESS

Thicker steel means a stronger sink. Casafendi Collection is made with 2.00mm thickness, Casaitalia Collection are made with 1.50mm thickness and Casastep, Casanova, Casablanca, Casabar, Casaboard(CBL) & Casavouge (Hydraulic Press) Collections are made with high grade 1.00mm thickness in AISI - 304 (18/8) Stainless Steel (18% Chromium, 8% Nickel), this collection is exceptionally long-lasting, rust-resistant and dent-resistant.



AISI - 316 MARINE GRADE

Casamarine Collection is made with high grade 1.00mm thickness AISI - 316 (18/10) stainless steel (18% Chromium, 10% Nickel). As it contains "Molybdenum", which gives it much better protection against salt, chemicals, and moisture. That's why AISI - 316 is used in marine equipment and medical tools-it lasts longer, even in harsh conditions.

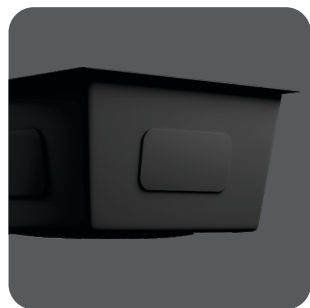

CROBIAL COAT TECHNOLOGY

Crobial Coat is a durable, clear protective black coating providing protection for surfaces from rust, tarnish, corrosion and oxidation. Crobial Coat has built in Antimicrobial technology for an added level of protection against the growth of microbes

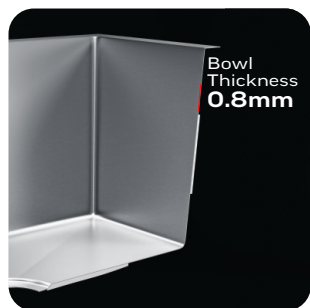

BOWL THICKNESS

Lacasa uses 0.80mm thick steel for project segments in Casabella & Casaboard(CBE) Collections with AISI - 304 (18/8) Stainless Steel (18% Chromium, 8% Nickel). This makes the sinks less vulnerable to denting and bending even after years of receiving knocks from utensils.

OUR PEOPLE & PASSION

Our team is young and dynamic, with a strong-driven multicultural mission. Our people use their passion, enthusiasm and highly specialised skills to turn the important targets to achieve a win-win situation. Our Ambition is to create high quality, exclusive products that enrich people's lives by combining the best of Italian creativity and technology with integrity and tradition of Indian manufacturers. Only by creating a successful and well-integrated team of most talented members in history with tradition, and values to deliver excellence.

AWARDS AND ACCOLADES

ISO 9001:2008 Certificate for Implementing a Quality Management System

CE Certificate for Establishing and Manufacturer with European health, safety, and environmental protection standards

ISO 14001:2015 Certificate for Implementing an Environmental Management System



A rising brand with creative and innovative ideas.



Only stainless steel company in India to be conferred with green sustainability.



International Management Certification for Implementing and improving recycle performance.

Always look for



authentic hologram on each sink



Made in India for the World

LACASA STEEL SUPPLIER



JINDAL STAINLESS STEEL

Lacasa Stainless Steel sinks are manufacture with premium materials sourced directly from Jindal Steel, backed by a Memorandum of Understanding (MOU) that guarantees authenticity and quality. Our sinks feature high-grade stainless steel, including AISI 316 and 304 steel grade. By partnering with Jindal Steel and using high-quality materials, we ensure that our sinks meet the highest standards of quality, durability, and performance.

Lacasa jindal steel license mou number, renewed every year.

LACASA WARRANTY



25 Years Warranty

All Lacasa handmade stainless steel 304 grade sinks are guaranteed for 25 years against fully workmanship & material.



5 Years Warranty

All Lacasa hydraulic press foaming steel 304 grade sinks are guaranteed for 5 years against fully workmanship & material.



1 Year Warranty

All Lacasa drainage coupling, steel colander tray, taps, accessories are guaranteed for 1 year against fully workmanship and material.

For more information about lacasa product warranty visit page no. 52

DISCLAIMER

The overall sizes & bowl sizes indicated are in mm and inches, Which are rounded off to the nearest decimal. For Granite Cutting please refer the dimensions from actual product only. Lacasa will not be responsible for any mistake during granite cutting. Lacasa reserves the right to alter models, prices and specification without any prior notice.

COLLECTIONS 2026

- 14 CASASTEP WORKSTATION
- 16 CASASTEP FAMILY - WORKSTATION
- 18 CASANOVA
- 20 CASAMARINE
- 21 CASABAR
- 22 CASAFENDI
- 24 CASAITALIA
- 26 CASABOARD
- 28 CASABLANCA
- 32 CASABELLA
- 36 CASAVOGUE - PRESS

- 38 LACASA GLASS RINSER
- 39 LACASA DISH DRYER
- 40 LACASA BESPOKE ENGINEERED
- 44 LACASA BRASS FAUCET
- 49 ACCESSORIES

- 50 LACASA POLICY
- 51 LACASA GUIDELINES
- 52 WARRANTY POLICY
- 53 LACASA SHORT TIMELINE
- 55 ARRIVING SOON...
- 55 TECHNICAL PARAMETERS
- 55 REGISTER YOUR PRODUCT

LACASA
SINK YOU DESIRE



CASASTEP COLLECTION

(WORKSTATION)



Model No.	Overall Size	Bowl Size	MRP(₹)
CSPL 2418	610 x 458 x 225mm 24" x 18" x 9"	560 x 400 x 225mm 22" x 16" x 9"	17990/-
CSPL 3018	760 x 458 x 225mm 30" x 18" x 9"	710 x 400 x 225mm 28" x 16" x 9"	18775/-

Including Accessories



SSCT 02
Colander Tray

WCB 03
Wooden Chopping

RMR 02
Roll Mat

RDR 01
Sink Drainer

CASASTEP COLLECTION (1.00mm Thickness - Durashield PU Coat)

LACASA
SINK YOU DESIRE



Model No.	Overall Size	Bowl Size	MRP(₹)
CSPL 2420 T	610 x 508 x 225mm 24" x 20" x 9"	560 x 400 x 225mm 22" x 16" x 9"	28055/- (with faucet CF 02)
CSPL 2420 T	610 x 508 x 225mm 24" x 20" x 9"	560 x 400 x 225mm 22" x 16" x 9"	32430/- (with faucet MF 01)
CSPL 2420 T	610 x 508 x 225mm 24" x 20" x 9"	560 x 400 x 225mm 22" x 16" x 9"	37535/- (MF 02 + CGR 01)
CSPL 3020 T	760 x 508 x 225mm 30" x 20" x 9"	710 x 400 x 225mm 28" x 16" x 9"	28840/- (with faucet CF 02)
CSPL 3020 T	760 x 508 x 225mm 30" x 20" x 9"	710 x 400 x 225mm 28" x 16" x 9"	33220/- (with faucet MF 01)
CSPL 3020 T	760 x 508 x 225mm 30" x 20" x 9"	710 x 400 x 225mm 28" x 16" x 9"	38320/- (MF 02 + CGR 01)

Including Accessories



SSCT 02
Colander Tray

WCB 03
Wooden Chopping

RMR 02
Roll Mat

RDR 01
Sink Drainer



WD 01
Water Dispenser

Faucet Options



MF 01
Mixer Faucet

MF 02
Mixer Faucet

CF 02
Cold Faucet

Glass Risner



CGR 01
Glass Risner



Model No.	Overall Size	Bowl Size	MRP(₹)
CSPL 5518	1400 x 458 x 225mm 55" x 18" x 9"	1340 x 400 x 225mm 53" x 16" x 9"	70100/-

Including Accessories

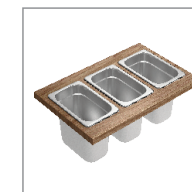

CBB 01
Condiment Board & Bowl



CBB 02
Condiment Board & Bowl



CBB 03
Colander Bowl & Board



CBB 04
Condiment Board & Bowl



WCB 04
Wooden Chopping

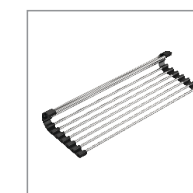

RMR 02
Roll Mat



RDR 01
Sink Drainer

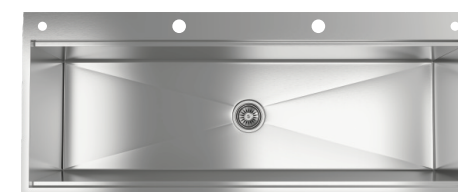

Model No.	Overall Size	Bowl Size	MRP(₹)
CSPL 5520 T	1400 x 508 x 225mm 55" x 20" x 9"	1340 x 400 x 225mm 53" x 16" x 9"	101000/-

Including Accessories



CBB 01
Condiment Board & Bowl



CBB 02
Condiment Board & Bowl



CBB 03
Colander Bowl & Board



CBB 04
Condiment Board & Bowl



WCB 04
Wooden Chopping

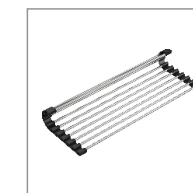

RMR 02
Roll Mat



RDR 01
Sink Drainer



CGR 01
Glass Risner



MF 01
Mixer Faucet



CF 01
Cold Faucet



WD 01
Water Dispenser



Model No.	Overall Size	Bowl Size	MRP(₹)
CNAL 2220 T	560 x 505 x 225mm 22" x 20" x 9"	510 x 400 x 225mm 20" x 16" x 9"	27960/- (with faucet CF 04)
CNAL 2420 T	610 x 508 x 225mm 24" x 20" x 9"	560 x 400 x 225mm 22" x 16" x 9"	28445/- (with faucet CF 03)
CNAL 2720 T	685 x 508 x 225mm 27" x 20" x 9"	635 x 400 x 225mm 25" x 16" x 9"	31410/- (with faucet CF 01)

Including Accessories

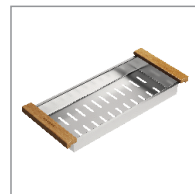

SSCT 01
Colander Tray



WCB 02
Wooden Chopping

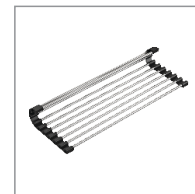

RMR 01
Roll Mat



RDR 01
Sink Drainer



WD 01
Water Dispenser



SD 01
Soap Dispenser

Faucet Options



CF 04
Cold Faucet



CF 03
Cold Faucet



CF 01
Cold Faucet



Model No.	Overall Size	Bowl Size	MRP(₹)
CNAL 2118	530 x 458 x 225mm 21" x 18" x 9"	480 x 400 x 225mm 19" x 16" x 9"	15120/-
CNAL 2218	560 x 458 x 225mm 22" x 18" x 9"	510 x 400 x 225mm 20" x 16" x 9"	15360/-
CNAL 2418	610 x 458 x 225mm 24" x 18" x 9"	560 x 400 x 225mm 22" x 16" x 9"	15595/-

Including Accessories

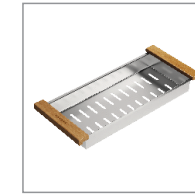

SSCT 01
Colander Tray

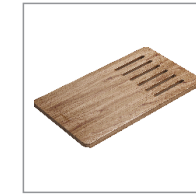

WCB 02
Wooden Chopping



RDR 01
Sink Drainer



Model No.	Overall Size	Bowl Size	MRP(₹)
CNAL 3718 T DB	940 x 458 x 225mm 37" x 18" x 9"	431 x 400 x 225mm 17" x 16" x 9"	32385/-
		431 x 350 x 225mm 17" x 14" x 9"	

Including Accessories



CGR 01
Glass Risner



CF 01
Cold Faucet



RDR 01
Sink Drainer



Model No.	Overall Size	Bowl Size	MRP(₹)
CNAL 3620 T DR	920 x 508 x 225mm 36" x 20" x 9"	470 x 400 x 225mm 18.5" x 16" x 9"	38545/-

Including Accessories



CGR 01
Glass Risner



MF 01
Mixer Faucet



SD 01
Soap Dispenser



RDR 01
Sink Drainer

CASAMARINE COLLECTION

MARINE GRADE AISI-316



Including Accessories



RDR01
SINK DRAINER

Made for tough kitchens, Our Casamarine collection sinks use High Grade AISI - 316 (18/10) Stainless Steel (18% Chromium, 10% Nickel) the highest quality steel used in kitchen sinks.

Most sinks in the market are made from 304 grade steel, which is strong and rust-resistant. But 316 grade goes a step further. It contains molybdenum, which gives it much better protection against salt, chemicals, and moisture. That's why 316 is used in marine equipment and medical tools-it lasts longer, even in harsh conditions.

316 vs 304 - What's the difference?

Better rust resistance - 316 holds up in coastal areas, wet kitchens, and with strong cleaners.

Stronger over time - No surface wear or dullness with regular use.

Easier to clean - Less chance of stains or marks sticking to the surface.

More hygienic - Fewer spots for bacteria to grow.



Model No.	Overall Size	Bowl Size	MRP(₹)
CMGL 2418	610 x 458 x 225mm 24" x 18" x 9"	560 x 400 x 225mm 22" x 16" x 9"	38275/-

*1.00mm Thickness - Durashield PU Coat

CASABAR COLLECTION

(1.00mm Thickness - Durashield PU Coat)

LACASA

SINK YOU DESIRE



Model No.	Overall Size	Bowl Size	MRP(₹)
CBRL 1820 T	458 x 508 x 225mm 18" x 20" x 9"	400 x 400 x 225mm 16" x 16" x 9"	39550/-

Including Accessories



CGR 01
Glass Risers



WCB 05
Wooden Chopping



CCB 04
Condiment Board & Bowl



MF 02
Mixer Faucet



WD 01
Water Dispenser



RDR 01
Sink Drainer





Including Accessories



RDR01
SINK DRAINER
AISI 304



Model No.	Overall Size	Bowl Size	MRP(₹)
CFNL 2418	610 x 458 x 225mm 24" x 18" x 9"	560 x 400 x 225mm 22" x 16" x 9"	28005/-

Role of Steel Thickness in a Kitchen Sink's Life – 2 mm Steel

Experience next level craftsmanship with Fendi kitchen sinks feature premium 14-gauge stainless steel, a 2 mm bowl sink offers exceptional structural strength, allowing it to withstand daily impacts from cookware, temperature changes, and heavy use without flexing or deforming. This protects a stable foundation for superior craftsmanship. Clean edges, consistent depth, and ensuring the sink continues to look and perform as intended for years.

Thickness:

2mm bowl thickness is the highest bowl in india.

Durable:

Constructed of superior quality 14-gauge stainless steel.

Quiet & Comfortable:

Heavier steel naturally absorbs sound and vibration for a serene kitchen experience.

Durashield Pu Coat Technology:

Durashield PU waterproof coating from house of Lacasa is finish application results in a white color coating that bonds completely to the steel, greatly improving durability and clean ability, odourless with superior resistance to abrasion, chips, and corrosion. It helps in maintaining water temperature in sink, also improves heat retention in winter.



Including Accessories



RDR01
SINK DRAINER
AISI 304

DURASHIELD PU COAT TECHNOLOGY

Durashield PU waterproof coating from house of Lacasa is finish application results in a white color coating that bonds completely to the steel, greatly improving durability and clean ability, odourless with superior resistance to abrasion, chips, and corrosion. It helps in maintaining water temperature in sink, also improves heat retention in winter.

BOWL THICKNESS

Casaitalia Collection is made with high grade 1.50mm thickness.



Model No.	Overall Size	Bowl Size	MRP(₹)
CITL 1818	450 x 450 x 225mm 18" x 18" x 9"	400 x 400 x 225mm 16" x 16" x 9"	17010/-
CITL 2118	530 x 450 x 225mm 21" x 18" x 9"	480 x 400 x 225mm 19" x 16" x 9"	20950/-
CITL 2418	610 x 458 x 225mm 24" x 18" x 9"	560 x 400 x 225mm 22" x 16" x 9"	21740/-
CITL 3018	760 x 458 x 225mm 30" x 18" x 9"	710 x 400 x 225mm 28" x 16" x 9"	23000/-



Model No.	Overall Size	Bowl Size	MRP(₹)
CITL 1820 T	450 x 508 x 225mm 18" x 20" x 9"	400 x 400 x 225mm 16" x 16" x 9"	17640/-
CITL 2420 T	610 x 508 x 225mm 24" x 20" x 9"	560 x 400 x 225mm 22" x 16" x 9"	22365/-
CITL 3020 T	760 x 508 x 225mm 30" x 20" x 9"	710 x 400 x 225mm 28" x 16" x 9"	23940/-



Model No.	Overall Size	Bowl Size	MRP(₹)
CITL 3418 DB	865 x 458 x 225mm 34" x 18" x 9"	395 x 400 x 225mm 17" x 16" x 9"	29925/-
		395 x 400 x 225mm 17" x 16" x 9"	
CITL 3718 DB	940 x 458 x 225mm 37" x 18" x 9"	431 x 400 x 225mm 17" x 16" x 9"	30715/-
		431 x 400 x 225mm 17" x 16" x 9"	



Model No.	Overall Size	Bowl Size	MRP(₹)
CITL 4520 T DB	1145 x 508 x 225mm 45" x 20" x 9"	535 x 450 x 225mm 21" x 18" x 9"	32024/-
		535 x 400 x 225mm 21" x 16" x 9"	



Model No.	Overall Size	Bowl Size	MRP(₹)
CITL 3620 T DR	920 x 508 x 225mm 36" x 20" x 9"	470 x 407 x 225mm 18.5" x 16" x 9"	28350/-
CITL 4020 T DR	1015 x 508 x 225mm 40" x 20" x 9"	560 x 407 x 225mm 22" x 16" x 9"	29925/-



Including Accessories



RDR01
SINK DRAINER
AISI 304



Model No.	Overall Size	Bowl Size	MRP(₹)
CBL 3618 DR RS	920 x 458 x 225mm 36" x 18" x 9"	470 x 407 x 225mm 18.5" x 16" x 9"	18115/-
CBL 3618 DR LS	920 x 458 x 225mm 36" x 18" x 9"	470 x 407 x 225mm 18.5" x 16" x 9"	18115/-
CBE 3618 DR RS	920 x 458 x 225mm 36" x 18" x 9"	470 x 407 x 225mm 18.5" x 16" x 9"	15595/-
CBE 3618 DR LS	920 x 458 x 225mm 36" x 18" x 9"	470 x 407 x 225mm 18.5" x 16" x 9"	15595/-



Model No.	Overall Size	Bowl Size	MRP(₹)
CBL 3620 T DR RS	920 x 508 x 225mm 36" x 20" x 9"	470 x 407 x 225mm 18.5" x 16" x 9"	18585/-
CBL 3620 T DR LS	920 x 508 x 225mm 36" x 20" x 9"	470 x 407 x 225mm 18.5" x 16" x 9"	18585/-
CBL 4020 T DR	1015 x 508 x 225mm 40" x 20" x 9"	560 x 407 x 225mm 22" x 16" x 9"	22050/-
CBE 3620 T DR RS	920 x 508 x 225mm 36" x 20" x 9"	470 x 407 x 225mm 18.5" x 16" x 9"	16065/-
CBE 3620 T DR LS	920 x 508 x 225mm 36" x 20" x 9"	470 x 407 x 225mm 18.5" x 16" x 9"	16065/-



Model No.	Overall Size	Bowl Size	MRP(₹)
CBL 4420 DB DR T	1115 x 508 x 225mm 44" x 20" x 9"	355 x 407 x 225mm 14" x 16" x 9"	26145/-
		340 x 407 x 225mm 13" x 16" x 9"	

Note:

Model Code CBL Represent casablanca collection in 1.00mm bowl thickness with Durashiled Pu Coat.
Model Code CBE Represent casabella collection in 0.80mm bowl thickness with Crobial coat.



RS (Right Side Drain Board)



LS (Left Side Drain Board)



Including Accessories



RDR01
SINK DRAINER
AISI 304

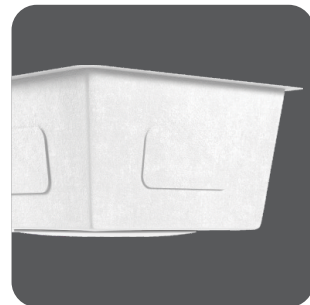

DURASHIELD PU COAT TECHNOLOGY

Durashield PU waterproof coating from house of Lacasa is finish application results in a white color coating that bonds completely to the steel, greatly improving durability and clean ability, odourless with superior resistance to abrasion, chips, and corrosion. It helps in maintaining water temperature in sink, also improves heat retention in winter.

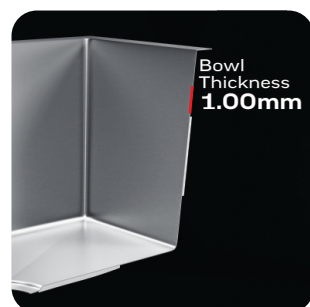

BOWL THICKNESS

Thicker steel means a stronger sink. Casablanca Collection is made with high grade 1.00mm thick AISI-304 stainless steel, this collection is exceptionally long-lasting and dent-resistant.



Model No.	Overall Size	Bowl Size	MRP(₹)
CBL 1618	400 x 450 x 225mm 16" x 18" x 9"	350 x 400 x 225mm 14" x 16" x 9"	10000/-
CBL 1717	430 x 430 x 225mm 17" x 17" x 9"	375 x 375 x 225mm 15" x 15" x 9"	10710/-
CBL 1818	450 x 450 x 225mm 18" x 18" x 9"	400 x 400 x 225mm 16" x 16" x 9"	10870/-
CBL 2017	508 x 430 x 225mm 20" x 17" x 9"	450 x 375 x 225mm 18" x 15" x 9"	11025/-
CBL 2118	530 x 450 x 225mm 21" x 18" x 9"	480 x 400 x 225mm 19" x 16" x 9"	11185/-
CBL 2218	555 x 458 x 225mm 22" x 18" x 9"	505 x 400 x 225mm 20" x 16" x 9"	11420/-
CBL 2418	610 x 458 x 225mm 24" x 18" x 9"	560 x 400 x 225mm 22" x 16" x 9"	11655/-
CBL 2718	685 x 458 x 225mm 27" x 18" x 9"	635 x 400 x 225mm 25" x 16" x 9"	11970/-
CBL 3018	760 x 458 x 225mm 30" x 18" x 9"	710 x 400 x 225mm 28" x 16" x 9"	12445/-
CBL 3218	810 x 458 x 225mm 32" x 18" x 9"	760 x 400 x 225mm 30" x 16" x 9"	12600/-
CBL 2420	610 x 508 x 225mm 24" x 20" x 9"	560 x 450 x 225mm 22" x 18" x 9"	11970/-
CBL 2720	685 x 508 x 225mm 27" x 20" x 9"	635 x 450 x 225mm 25" x 18" x 9"	12285/-
CBL 3020	760 x 508 x 225mm 30" x 20" x 9"	710 x 450 x 225mm 28" x 18" x 9"	12760/-





Model No.	Overall Size	Bowl Size	MRP(₹)
CBL 2418 T	610 x 458 x 225mm 24" x 18" x 9"	560 x 350 x 225mm 22" x 14" x 9"	12130/-
CBL 1820 T	450 x 508 x 225mm 18" x 20" x 9"	400 x 400 x 225mm 16" x 16" x 9"	11340/-
CBL 2120 T	530 x 508 x 225mm 21" x 20" x 9"	480 x 400 x 225mm 19" x 16" x 9"	11970/-
CBL 2220 T	555 x 508 x 225mm 22" x 20" x 9"	505 x 400 x 225mm 20" x 16" x 9"	12205/-
CBL 2420 T	610 x 508 x 225mm 24" x 20" x 9"	560 x 400 x 225mm 22" x 16" x 9"	12445/-
CBL 2422 T	610 x 560 x 225mm 24" x 22" x 9"	560 x 450 x 225mm 22" x 18" x 9"	12760/-
CBL 2720 T	685 x 508 x 225mm 27" x 20" x 9"	635 x 400 x 225mm 25" x 16" x 9"	12760/-
CBL 3020 T	760 x 508 x 225mm 30" x 20" x 9"	710 x 400 x 225mm 28" x 16" x 9"	13230/-
CBL 3220 T	810 x 508 x 225mm 32" x 20" x 9"	760 x 400 x 225mm 30" x 16" x 9"	13390/-



Model No.	Overall Size	Bowl Size	MRP(₹)
CBL 3718 DB	940 x 458 x 225mm 37" x 18" x 9"	431 x 400 x 225mm 17" x 16" x 9"	18900/-
		431 x 400 x 225mm 17" x 16" x 9"	
CBL 4020 DB	1015 x 508 x 225mm 40" x 20" x 9"	470 x 450 x 225mm 18.5" x 18" x 9"	19690/-
		470 x 450 x 225mm 18.5" x 18" x 9"	
CBL 4520 DB	1145 x 508 x 225mm 45" x 20" x 9"	535 x 450 x 225mm 21" x 18" x 9"	20475/-
		535 x 450 x 225mm 21" x 18" x 9"	



Model No.	Overall Size	Bowl Size	MRP(₹)
CBL 3218 T DB	810 x 458 x 225mm 32" x 18" x 9"	367.5 x 400 x 225mm 14" x 16" x 9"	18585/-
		367.5 x 350 x 225mm 14" x 14" x 9"	
CBL 3718 T DB	940 x 458 x 225mm 37" x 18" x 9"	431 x 400 x 225mm 17" x 16" x 9"	19375/-
		431 x 350 x 225mm 17" x 14" x 9"	
CBL 4520 T DB	1145 x 508 x 225mm 45" x 20" x 9"	535 x 450 x 225mm 21" x 18" x 9"	20950/-
		535 x 400 x 225mm 21" x 16" x 9"	





Including Accessories



RDR01
SINK DRAINER
AISI 304

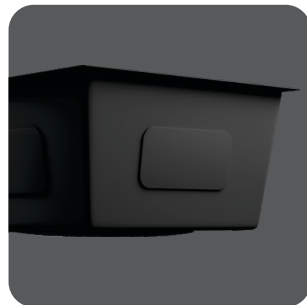

CROBIAL COAT TECHNOLOGY

Crobial Coat is a durable, clear protective black coating providing protection for surfaces from rust, tarnish, corrosion and oxidation. Crobial Coat has built in Antimicrobial technology for an added level of protection against the growth of microbes

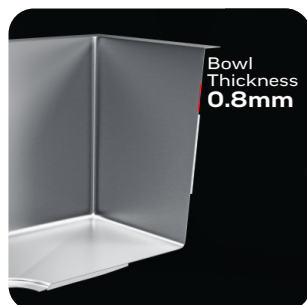

BOWL THICKNESS

Lacasa uses 0.8mm thick steel for project segments. This makes the sinks less vulnerable to denting and bending even after years of receiving knocks from utensils.



Model No.	Overall Size	Bowl Size	MRP(₹)
CBE 1618	400 x 450 x 225mm 16" x 18" x 9"	350 x 400 x 225mm 14" x 16" x 9"	8505/-
CBE 1818	450 x 450 x 225mm 18" x 18" x 9"	400 x 400 x 225mm 16" x 16" x 9"	8820/-
CBE 2017	508 x 430 x 225mm 20" x 17" x 9"	450 x 375 x 225mm 18" x 15" x 9"	8980/-
CBE 2118	530 x 458 x 225mm 21" x 18" x 9"	480 x 400 x 225mm 19" x 16" x 9"	9135/-
CBE 2218	555 x 458 x 225mm 22" x 18" x 9"	505 x 400 x 225mm 20" x 16" x 9"	9295/-
CBE 2418	610 x 458 x 225mm 24" x 18" x 9"	560 x 400 x 225mm 22" x 16" x 9"	9450/-
CBE 2718	685 x 458 x 225mm 27" x 18" x 9"	635 x 400 x 225mm 25" x 16" x 9"	10080/-
CBE 3018	760 x 458 x 225mm 30" x 18" x 9"	710 x 400 x 225mm 28" x 16" x 9"	10555/-
CBE 3218	810 x 458 x 225mm 32" x 18" x 9"	760 x 400 x 225mm 30" x 16" x 9"	10870/-
CBE 2420	610 x 508 x 225mm 24" x 20" x 9"	560 x 450 x 225mm 22" x 18" x 9"	9765/-
CBE 2720	685 x 508 x 225mm 27" x 20" x 9"	635 x 450 x 225mm 25" x 18" x 9"	10395/-
CBE 3020	760 x 508 x 225mm 30" x 20" x 9"	710 x 450 x 225mm 28" x 18" x 9"	10870/-





Model No.	Overall Size	Bowl Size	MRP(₹)
CBE 2418 T	610 x 458 x 225mm 24" x 18" x 9"	560 x 350 x 225mm 22" x 14" x 9"	9925/-
CBE 1820 T	450 x 508 x 225mm 18" x 20" x 9"	400 x 400 x 225mm 16" x 16" x 9"	9545/-
CBE 2120 T	530 x 508 x 225mm 21" x 20" x 9"	480 x 400 x 225mm 19" x 16" x 9"	9925/-
CBE 2220 T	555 x 508 x 225mm 22" x 20" x 9"	505 x 400 x 225mm 20" x 16" x 9"	10080/-
CBE 2420 T	610 x 508 x 225mm 24" x 20" x 9"	560 x 400 x 225mm 22" x 16" x 9"	10240/-
CBE 2720 T	685 x 508 x 225mm 27" x 20" x 9"	635 x 400 x 225mm 25" x 16" x 9"	10870/-
CBE 3020 T	760 x 508 x 225mm 30" x 20" x 9"	710 x 400 x 225mm 28" x 16" x 9"	11340/-
CBE 3220 T	810 x 508 x 225mm 32" x 20" x 9"	760 x 400 x 225mm 30" x 16" x 9"	11460/-



Model No.	Overall Size	Bowl Size	MRP(₹)
CBE 3718 DB	940 x 458 x 225mm 37" x 18" x 9"	430 x 400 x 225mm 17" x 16" x 9"	16855/-
		430 x 400 x 225mm 17" x 16" x 9"	
CBE 4020 DB	1015 x 508 x 225mm 40" x 20" x 9"	470 x 450 x 225mm 18.5" x 18" x 9"	17800/-
		470 x 450 x 225mm 18.5" x 18" x 9"	
CBE 4520 DB	1145 x 508 x 225mm 45" x 20" x 9"	535 x 450 x 225mm 21" x 18" x 9"	18430/-
		535 x 450 x 225mm 21" x 18" x 9"	

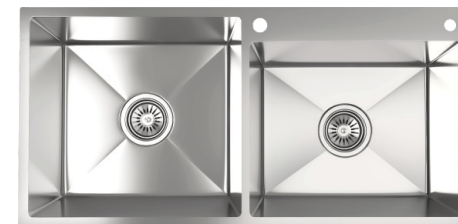

Model No.	Overall Size	Bowl Size	MRP(₹)
CBE 3218 T DB	810 x 458 x 225mm 32" x 18" x 9"	367.5 x 400 x 225mm 14" x 16" x 9"	15595/-
		367.5 x 350 x 225mm 14" x 14" x 9"	
CBE 3718 T DB	940 x 458 x 225mm 37" x 18" x 9"	430 x 400 x 225mm 17" x 16" x 9"	17325/-
		430 x 350 x 225mm 17" x 14" x 9"	
CBE 4520 T DB	1145 x 508 x 225mm 45" x 20" x 9"	535 x 450 x 225mm 21" x 18" x 9"	18900/-
		535 x 400 x 225mm 21" x 16" x 9"	



CASAVOGUE COLLECTION

(1.00mm Thickness - Durashield PU Coat)



Including Accessories



RDR03
Sink Drainer



DURASHIELD PU COAT TECHNOLOGY

Durashield PU waterproof coating from house of Lacasa is finish application results in a white color coating that bonds completely to the steel, greatly improving durability and clean ability, odourless with superior resistance to abrasion, chips, and corrosion. It helps in maintaining water temperature in sink, also improves heat retention in winter.



BOWL THICKNESS

Casavogue Collection is made with foaming steel grade with 1.00mm thick AISI-304 stainless steel. (Hydraulic Press)

CASAVOGUE COLLECTION (1.00mm Thickness - Durashield PU Coat)

LACASA
SINK YOU DESIRE



Model No.	Overall Size	Bowl Size	MRP(₹)
CVGL 1618	405 x 458 x 205mm 16" x 18" x 8"	355 x 405 x 205mm 14" x 16" x 8"	7110/-
CVGL 1818	458 x 458 x 205mm 18" x 18" x 8"	405 x 405 x 205mm 16" x 16" x 8"	7775/-
CVGL 2017	510 x 430 x 205mm 20" x 17" x 8"	458 x 380 x 205mm 18" x 15" x 8"	8315/-
CVGL 2118	535 x 458 x 205mm 21" x 18" x 8"	480 x 405 x 205mm 19" x 16" x 8"	8480/-
CVGL 2218	560 x 458 x 205mm 22" x 18" x 8"	510 x 405 x 205mm 20" x 16" x 8"	8955/-
CVGL 2418	610 x 458 x 230mm 24" x 18" x 9"	560 x 405 x 230mm 22" x 16" x 9"	9425/-
CVGL 2420	610 x 510 x 230mm 24" x 20" x 9"	560 x 458 x 230mm 22" x 18" x 9"	11435/-
CVGL 2721	685 x 535 x 230mm 27" x 21" x 9"	610 x 458 x 230mm 24" x 18" x 9"	12855/-



Model No.	Overall Size	Bowl Size	MRP(₹)
CVGL 3718 DB	940 x 458 x 230mm 37" x 18" x 9"	430 x 400 x 225mm 16" x 14" x 8"	14245/-
CVGL 4520 DB	1145 x 500 x 230mm 45" x 20" x 9"	510 x 405 x 230mm 20" x 16" x 9"	17435/-



Model No.	Overall Size	Bowl Size	MRP(₹)
CVGL 3718 DR	940 x 458 x 205mm 37" x 18" x 8"	355 x 405 x 205mm 14" x 16" x 8"	10965/-
CVGL 4120 DR	1040 x 510 x 205mm 41" x 20" x 8"	480 x 405 x 205mm 19" x 16" x 8"	13325/-

Suggested Accessories



CF 05
Cold Faucet



WCB 01
Wooden Chopping

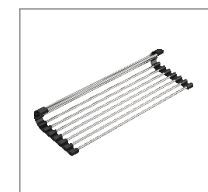

RMR 01
Roll Mat

LACASA GLASS RINSER

The Smarter Way to Rinse



The Lacasa Glass Rinser uses powerful water jets to blast away residue in seconds. With a 5 inch opening that accommodates larger containers like wine glasses, baby bottles, and even travel mugs, ensuring a thorough rinse. The design features 9 jets that are optimally angled to clean containers of any style, with 6 soft silicone strips that support delicate glassware. An integrated lock system helps prevent accidental activation. The spacious sloped opening ensures quick water drainage directly into the sink, keeping counter tops dry.

POWERFUL PERFORMANCE

Designed to blast away residue in seconds with powerful water jets

LARGE OPENING

Wide 5 inch opening accommodates containers of all sizes, from wine glasses to tumblers

INTUITIVE OPERATION

An integrated lock system helps prevent accidental activation

BUILT TO LAST

Durable construction helps ensure lasting use



Model No.	Material	Lever	MRP(₹)
CGR 01	Stainless Steel 304	Single	5450/-

LACASA DISH DRYER

LACASA
SINK YOU DESIRE



Model No.	Overall Size	Bowl Size	MRP(₹)
CDDL 208	500 x 200 x 150mm 20" x 8" x 6"	460 x 160 x 150mm 18" x 6" x 6"	10870/-

Including Accessories

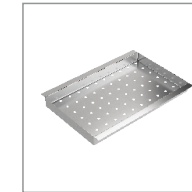

LDCH 01
Cup Holder

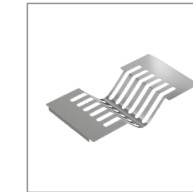

LDPR 01
Dish Plate Rack



Model No.	Overall Size	Bowl Size	MRP(₹)
CDDL 408	1000 x 200 x 150mm 40" x 8" x 6"	960 x 160 x 150mm 38" x 6" x 6"	14490/-

Including Accessories



LDCH 02
Cup Holder

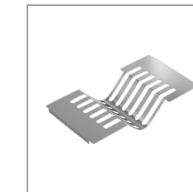

LDPR 01
Dish Plate Rack

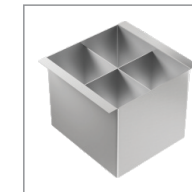

LDCH 01
Cutlery Holder



Rust Proof | Life Time Warranty | Posh Finish | 100% Non Magnetic

INTRODUCING LACASA BESPOKE ENGINEERED SINK

The Exquisite Art of Bespoke Engineering

A Journey into Quality, Luxury, and the Gentle Touch of Style

Lacasa is dedicated to the art of bespoke engineered kitchen solutions for those who value classic, timeless design. We create enduring pieces that transcend trends, offering a refined collection of handcrafted steel sinks designed to elevate the heart of your home.

Our team of skilled designers and engineer craftsmen work closely together to create handmade sinks that seamlessly complement your kitchen's architecture and personal style. Every Lacasa sink is thoughtfully engineered, meticulously crafted, and built to last a lifetime.

Each bespoke handmade steel sink is created entirely from scratch to reflect the individual preferences of our clients. From the choice of steel grade to design details such as step-in styles, taps, double bowls, and drain boards, every element is tailored to your vision.

If you're about to embark on your first bespoke engineered sink experience, here's a step-by-step guide to help you understand the journey and what to expect along the way.

1. Initial Meeting:

The bespoke design journey begins with a personal consultation between our design team and the client. We explore style preferences, functional requirements, material selection, bowl thickness, outer coat and design possibilities, ensuring every detail aligns with the envisioned space.

This phase establishes a clear design vision while fostering a collaborative relationship between client and engineer, laying the foundation for a truly tailored masterpiece.

2. Measurements & Style Drafting:

Following the consultation, our team takes precise measurements to ensure a perfect fit. The engineer considers all relevant dimensions, including specific cut sizes in granite or marble, to ensure optimal style and comfort. Attention to detail is essential, as even minor discrepancies can affect the final result.

Using these measurements, our engineers create a unique pattern that serves as the blueprint for forging the stainless steel sink. Every style is tailored to the client's specification.

Details: Sink Length, Width, Tap hole sizes in mm.

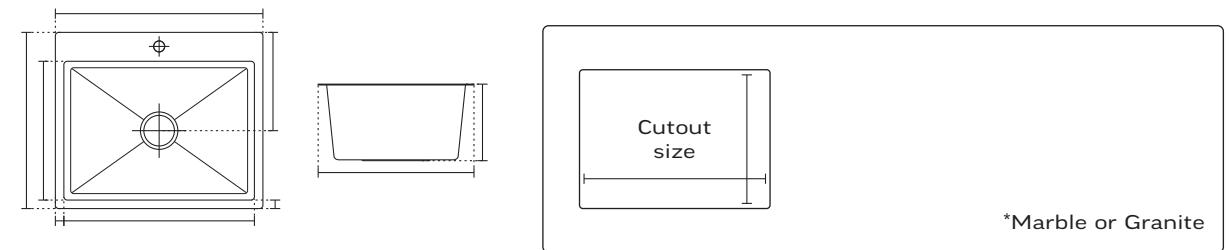

3. Material Selection:

Once measurements are finalized, bespoke sinks are crafted from finest quality Jindal materials, such as 316 or 304 steel, ensuring durability and longevity. Clients can choose from below options.



316 Stainless Steel: Enhanced with molybdenum for superior corrosion resistance, especially in saline or high-humidity environments, combining strength with premium longevity.



304 Stainless Steel: Offers excellent corrosion resistance and durability, ideal for residential and commercial use, with a smooth, long lasting hygienic finish.

Bowl Thickness:

2.00mm Thickness
Maximum strength and impact resistance for heavy-duty and high-traffic use. Ensures long-lasting durability with premium structural integrity.

1.50 mm Thickness
Balanced gauge combining strength and manageable weight. Ideal for frequent use in high-end residential spaces. Or corporate offices.

1.00 mm Thickness
Lightweight yet structurally reliable, offering controlled flexibility. Suitable for everyday residential and moderate commercial applications.

0.80 mm Thickness
Specially designed for projects in residential or commercial kitchens with smooth, durable performance.

Frame Thickness:

Fixed 2mm stainless steel frame ensures structural stability, secure support, and seamless countertop integration.

Outer Coating:

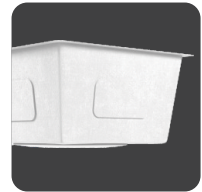

Durashield PU Coat

A white waterproof coating that bonds to steel, enhancing durability, abrasion resistance, and cleanability. Odourless, protects against chips and corrosion, and helps retain water temperature in the sink during winter or cold weather temperature.

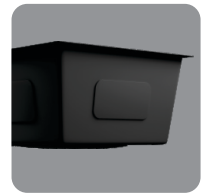

Crobial Coat

A clear black protective coating that guards against tarnish, and oxidation. Built-in antimicrobial technology adds protection against microbial growth, ensuring hygienic performance.

Classic Bowl Configuration:

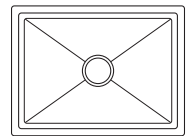

Single Bowl

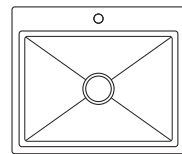

Single Bowl with Tap Hole

Classic, space-efficient design for residential or light commercial use, with optional tap integration.

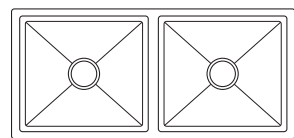

Double Bowl

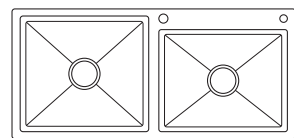

Double Bowl with Tap Hole

Versatile layout for simultaneous tasks, providing functionality and efficiency, with optional tap accommodation.

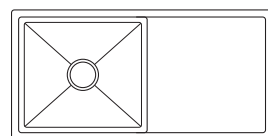

Single Bowl with Drainboard

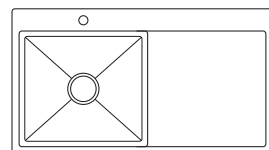

Single Bowl Drainboard with Tap Hole

Combines a practical workspace for washing and draining, with optional tap integration.

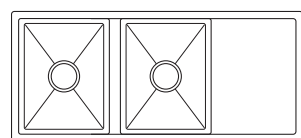

Double Bowl with Drainboard

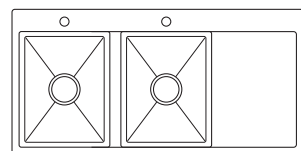

Double Bowl Drainboard with Tap Hole

Enhanced multitasking design, ideal for high-traffic kitchens, with optional tap placement for convenience.

Step Bowl Configuration:

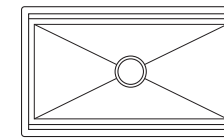

Step Sink Single Bowl

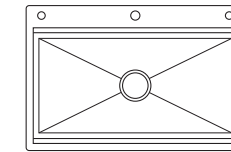

Step Sink Single Bowl with Tap Hole

The Step Sink features a multi-level bowl design, creating distinct zones for washing, rinsing, and draining. Engineered for enhanced workflow efficiency, it allows simultaneous tasks while maintaining water containment and cleanliness. Its sleek, ergonomic steps integrate seamlessly into modern kitchen layouts, combining functionality with architectural elegance.

* Requires a minimum 1.00 mm stainless steel construction to ensure structural integrity, durability, and optimal performance.

Selection of Faucets & Accessories:

Choose from a curated range of faucets and kitchen accessories designed to complement your bespoke sink.

Brass material options include mixer faucet, cold faucet, ro water faucet, soap dispenser.

Steel material options include: colander tray, roll mat, dish plate rack, cup holder, cutlery holder, condiment bowl, glass riser.

Teak wood material options include: chopping board, board with knife holder, condiment board, garnish bowl, knife holder.

4. Finishing Touch:

Once all specifications are finalized, the bespoke stainless steel sink enters the final construction stage. Our skilled engineers meticulously forge each sink, ensuring structural strength, durability, and a flawless finish. Techniques such as X-diversion, auto laser welding, auto corner radius and decorative elements are carefully crafted to enhance both aesthetics and functionality.

Personalized touches, including laser monograms or bespoke client requests, add exclusivity, making each sink truly one-of-a-kind.

5. Investment:

While a bespoke sink represents a higher initial investment than a standard option, it delivers enduring value through superior craftsmanship, longevity, and timeless design. Designed to withstand daily use and evolving trends, a custom sink eliminates the cycle of frequent replacements—offering a considered, long-term solution that rewards both style and comfort.

6. The Timeless Masterpiece:

After several weeks of meticulous craftsmanship, the bespoke handmade steel sink is complete. We conduct a final handover to ensure every aspect meets the client's expectations. This moment represents the culmination of the client's vision and the engineer's skill.



Redefine Your Kitchen with Lacasa Faucet

Experience the perfect balance of style and substance. Lacasa faucets are expertly crafted for modern living, featuring a solid brass body for unmatched durability.

Designed for seamless integration into any kitchen, our faucets feature an extended-reach spout for effortless rinsing and a premium Chrome finish that resists fading and corrosion. With precision engineering for smooth flow control and long-lasting cartridges, Lacasa promises exceptional performance—day after day, year after year.

Core Material: Solid Brass Body

Variations: Available in Cold Taps & Mixer Taps



CASCADE FLOW

This supreme technology creates a stress relieving work experience.



SOFT TURN

Soft Turn cartridge technology gives the user precise control over water flow & temperature. The development of this technology has been possible as we are one of the few importer from hassem, kerox cartridge & implemented in our faucets.



JOYSTICK TURN

An innovative concept in water control, Joystick technology presents a style which is distinct from the more traditional single lever, but which gives the same performance as Lacasa soft turn technology.



PROGRESSIVE TURN

Taps with progressive technology always start the flow with cold water & as you continually turn the control the flow changes to a mix of hot & cold meaning water systems are only activated when hot water is required thereby saving energy.



ECO DISC CARTRIDGE

This Lacasa exclusive technology helps to save water & energy. As the tap handle is moved, a slight resistance is reached at 50% of the water flow; lifting beyond this bite point produces a full flow. The cartridge has a temperature limiter which can be set at installation to eliminate the risk of scalding. The temperature limiter can be altered after installation.



EVER SHINE

Lacasa's innovative Ever Shine chrome plating system, involving electrolytic coating, produces a hard-wearing finish on all faucet taps. It helps to maintain the shine & makes for easy cleaning.



SAFE TOUCH

Development in materials has allowed Lacasa to develop Safe Touch technology which prevents the chrome plating on thermostatic fittings from overheating. This eliminates the risk of scalding & is particularly beneficial in environments used by the young, & the elderly.



QUICK REACTION

Quick Reaction technology ensures that Lacasa thermostatic fittings reach the required flow & temperature in less than 3 seconds. Both then remain constant, irrespective of variations in water pressure.

HOT & COLD TAP MIXTURE



Model No.	MF 01
Material	Brass
Finish	Chrome
Lever	Single
MRP(₹)	13595/-



Model No.	MF 02
Material	Brass
Finish	Chrome
Lever	Single
MRP(₹)	13240/-



COLD TAP



Model No.	CF 01
Material	Brass
Finish	Chrome
Lever	Single
MRP(₹)	9010/-



Model No.	CF 02
Material	Brass
Finish	Chrome
Lever	Single
MRP(₹)	7710/-



Model No.	CF 03
Material	Brass
Finish	Chrome
Lever	Single
MRP(₹)	5225/-



Model No.	CF 04
Material	Brass
Finish	Chrome
Lever	Single
MRP(₹)	4900/-

COLD TAP



Model No.	CF 05
Material	Brass
Finish	Chrome (Body)
Lever	Single
MRP(₹)	4440/-

Wall Mounted



Model No.	WCF 01
Material	Brass
Finish	Chrome
Lever	Single
MRP(₹)	5070/-

Water Dispenser



Model No.	WD 01
Material	Brass
Finish	Chrome
Lever	Single
MRP(₹)	5355/-

Soap Dispenser



Model No.	SD 01
Material	Brass
Finish	Chrome
Lever	Single
MRP(₹)	5040/-

ACCESSORIES COLLECTION



SINK DRAINER - AISI 304		
Model No.	Size (mm)	MRP(₹)
RDR 01	Ø114	950/-



SINK STRAINER - AISI 304		
Model No.	Size (mm)	MRP(₹)
RDR 02	Ø70	350/-



SINK DRAINER - AISI 304		
Model No.	Size (mm)	MRP(₹)
RDR 03	Ø114	800/-



ROLL MAT - AISI 204		
Model No.	Size (mm)	MRP(₹)
RMR 01	450 x 225	1700/-
RMR 02	390 x 225	1360/-



COLANDER TRAY - AISI 304		
Model No.	Size (mm)	MRP(₹)
SSCT 01	450 x 225	3510/-
SSCT 02	390 x 225	3190/-



WOODEN CHOPPING - KNIFE HOLDER		
Model No.	Size (mm)	MRP(₹)
WCB 02	430 x 250	2420/-
WCB 03	390 x 250	2020/-



WOODEN CHOPPING BOARD		
Model No.	Size (mm)	MRP(₹)
WCB 01	330 x 228	850/-

We thank you for choosing the Lacasa product & continued trust in us. Lacasa promises the highest level of quality product and services to give you a delightful experience.

WARRANTY FOR LACASA PRODUCTS:

We at Lacasa are confident that your handmade 304 grade. Stainless steel sinks will give you many years of trouble free operation, however for peace of mind all our products are covered by the following service warranty.

The products are warranted against any manufacturing defect specified under the warranty period subjects to terms and conditions.

Warranty Charts		Warranty In Years	
Product Grade	Product Collection	Residential Use	Commercial Use
AISI 304	Casastep - Workstation	25	5
AISI 304	Casastep Family - Workstation	25	5
AISI 304	Casanova	25	5
AISI 316	Casamarine	30	7
AISI 304	Casabar	25	5
AISI 304	Casafendi	25	5
AISI 304	Casaitalia	25	5
AISI 304	Casaboard	25	5
AISI 304	Casablanca	25	5
AISI 304	Casabella	25	5
AISI 304	Casavogue - Press	5	2
AISI 304	Lacasa Dish Dryer	25	5
AISI 304	Lacasa Glass Risner	1	0.5
Brass	Faucet Body - Mixer Hot & Cold Taps	10	5
Brass	Faucet Body - Cold Taps	10	5
Ceramic	Faucet Cartridge	1.5	0.5
Brass	Water Dispense Body	6	2
Brass	Soap Dispenser Body	6	2
Abs & Steel	Consumable Parts: Aerators, Flexible Hoses	Nil	Nil
AISI 304	Sink Drainer - RDR 01	1	0.5
AISI 304	Sink Stainer - RDR 02	1	0.5
AISI 304	Sink Drainer - RDR 03	1	0.5
AISI 304	Colander Tray	1	0.5
AISI 202	Roll Mat	0.6	0.3
Teak Wood	Wooden Chopping Board	Nil	Nil
Plastic	PVC Pipe with RDR 03 & SDR 01	Nil	Nil

GUIDELINES TO MAINTAIN LACASA STAINLESS STEEL SINK PRODUCTS

- Carefully inspect the new product for any damage before installation.
- Lacasa is not liable or shall not be responsible for any such damage or for improper installation. The installation should be done by trained technician.
- Clean the sink at least once a week. When cleaning use mild soapy water and rub in the direction of the grain lines, rinse and towel dry.
- Drying is important to eliminate collection of lime scale, mineral deposits and calcium stack.
- Always rinse the sink after every use and wipe dry.
- Avoid use of cleaners & bleachers containing harmful chemicals and acid.
- Avoid prolonged contact with citric or high salt concentration food as it can lead to staining, pitting and corrosion of the sink.
- Steel wool / wired brushes / abrasive sponge pads are not recommended for cleaning as it leads to scratches and rusting on the sink.
- Do not use the sink drain board as a cutting or chopping board as it will leave scratches on the sink.
- Do not remove the film coating on the sink before installation to avoid scratches and damage during installation. Remove the film only after installation, but before use.
- Remove all traces of cement, mortar, lime, POP etc. used during installation as it can lead to surface rusting or pitting.

GUIDELINES TO MAINTAIN LACASA BRASS FAUCET PRODUCTS

- Carefully inspect the new product for any damage before installation.
- Lacasa is not liable or shall not be responsible for any such damage or for improper installation. The installation should be done by trained technician.
- Water Scaling: Due to presence of minerals and salt in water, scaling is formed on the product if it is not cleaned regularly. The products should be cleaned gently at regular intervals. Also, take extra care to clean the edges and corners of the products because these areas are more vulnerable for scale settling.
- Clean the aerators from time to time for a perfect foam flow of water from the faucet. The property of water being used is very important for your plumbing installations (Pipes etc.)
- Acid Fumes: When we clean the tiles or floors in the bathroom with cleaning agents which contain acids or chemicals, acid fumes are formed. Because the basic material used in the products is brass, brass being an alloy of copper reacts with these acid fumes. with the reaction, a green coloured layer is formed on the products resulting in damage to the outer finish or coating.
- Scratching While Cleaning: Scratching or scrubbing occurs due to hard nature of cloth or coarse cleaning powder being used for cleaning. Use a gentle fluffy soft cloth for cleaning the surface.
- Atmospheric Conditions: This condition applies mostly to salt content in the air in coastal areas, sometimes the air reacts with brass and black spots emerge on the surface of product. Therefore the product is required to be cleaned regularly.
- At the time of installation of the products, cover the products with the cloth covers provided in packaging or with polythene till the time you actually start using them.

WARRANTY POLICY

Pricing: MRP and product specifications are subject to change without notice. Pricing for india purchase only.

Taxes: prices are inclusive of goods service taxes (GST).

Loss and/or damage in transit: our liability ceases upon delivery of the goods to the carrier at our warehouse. Claims for damage and/or loss in transit to be made by the consignee against the carrier.

Freight: prices are exclusive off freight.

Returned goods: returns will not be accepted without prior written authorisation from lacasa. Handling and reconditioning charges will be assessed and will be charged accordingly as required to restore the items to sale able condition.

Cancellation: on custom-made or standard models designed to customer's specification, and engineering charges will be assessed if order is cancelled before fabrication has commenced. Cancellation after fabrication / alteration is started will be result in a charge commensurate with the extent of work completed.

Lacasa sinks are warranty for free replacement against any major manufacturing defect. However, payment of or responsibility for transportation & installation costs (counter top) are excluded, the warranty is only for sink, and it will be exchanged with another sink. Eligibility of replacement shall be the sole discretion of manufacturer.

This warranty does not apply to defect or damage caused by: Failure to follow the recommended procedures for installation, care and maintenance.

This warranty is only effective if proof of purchase (original sales receipt) is provided with all warranty claims or requests.

(a) Date of purchase and installation.

(b) Description of nature of defect.

(c) Model number or description of model and/or component part if possible.

(d) The support of invoice / bill.

In case the purchase has been done by the developer of the apartment, the possession letter from the developer will be treated as equivalent to bill, if supplied by the company. (Require purchased bill if purchased from authorised dealer).

This warranty does not cover problems arising from excessive water impurities or improper care and cleaning. Lacasa is not responsible for labor charges, installation or other incidental or consequential costs.

All sizes are approximate ± 5 mm rounded off.

Due to continues research & development to improve the products, sizes & other specification can change without any prior notice.

Lacasa india reserves the right to amend the terms and conditions if necessary.

This is lacasa india's exclusive written warranty. The decision of lacasa india regarding the warranty is final and binding. All disputes are subject to the exclusive jurisdiction of the courts of morbi only.

W.E.F: 01-01-2026

LACASA SHORT TIMELINE

LACASA
SINK YOU DESIRE

1985

Our humble journey began with the establishment of manufacturing roofing tiles. (Nadiya)

1995

The first manufacturing unit of ceramic wall tiles by the name of Classic Ceramics Pvt. Ltd.

1998

Diversified Our Portfolio By Entering The Bathware Industry And Establishing Bell Sanitary wares India, with capacity of 0.09 million capacity per annum.

2010

Entered Import & Export of machinery, ceramic tools for local market in the name of Bell Impex India.

2011

Diversified Our Portfolio By Entering Decorative Laminates sheet and Establishment of Bell Laminates with 1500 sheet per day production capacity.

2014

Tie up with china company for suppling of cutting wheels in the name of zhuhai-bell into the Indian ceramic markets.

2015

Entered manufacturing of glaze application, glaze surfaces and glaze compound for supplying premium ceramic companies in morbi with the establishment of brand Pinoraz.

2018

Increased production capacity with unit 2 Bell bathworld 2.1 Million products annually.

2021

Diversified into Corrugated box packaging unit with name of Label packaging.

2024

Bell group enters manufacturing of finest handmade stainless steel sink with establishment of LACASA kitchenware products.

* You can find a brief timeline of our company's story on our website: www.lacasasink.com/lacasastory

